

SISTEMA

**NIRON**





TARIFA DE PRECIOS 2008

# Certificados de calidad



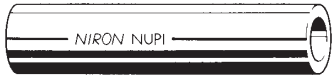
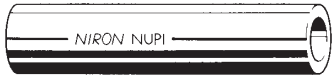

## TUBO NIRON MONOPARED

FIGURA	DESCRIPCIÓN	Ø	PRECIO	CONF.	CÓDIGO
		mm	€/m	m	
1	 <p>TUBO NIRON SDR6 EN BARRA DE 4 m. 70°C clase 2 - 8 bar 60°C clase 1 - 10 bar (PN20)</p>	16 x 2,7	1,16	100	TNIRR16
		20 x 3,4	1,17	100	TNIRR20
		25 x 4,2	2,14	100	TNIRR25
		32 x 5,4	3,35	60	TNIRR32
		40 x 6,7	5,30	40	TNIRR40
		50 x 8,4	8,09	20	TNIRR50
		63 x 10,5	12,76	16	TNIRR63
		75 x 12,5	18,36	12	TNIRR75
		90 x 15,0	28,49	8	TNIRR90
		110 x 18,4	42,92	8	TNIRR110
125 x 20,8	55,97	4	TNIRR125		
1 / 1	 <p>TUBO NIRON SDR7,4 EN BARRA DE 4 m. 70°C clase 2 - 6 bar 60°C clase 1 - 8 bar (PN16)</p>	25 x 3,5	1,89	100	TNIRR2516
		32 x 4,4	3,02	60	TNIRR3216
		40 x 5,5	4,82	40	TNIRR4016
		50 x 6,9	7,21	20	TNIRR5016
		63 x 8,7	11,24	16	TNIRR6316
		75 x 10,4	16,08	12	TNIRR7516
		90 x 12,5	27,44	8	TNIRR9016
		110 x 15,2	37,61	8	TNIRR11016
		125 x 17,1	47,99	4	TNIRR12516
		160 x 21,9	79,48	4	TNIRR16016
1 / 2	 <p>TUBO NIRON SDR11 EN BARRA DE 4 m. 20°C - 10 bar (PN10)</p> <p>Sólo para agua fría</p>	25 x 2,3	1,47	100	TNIRR2510
		32 x 2,9	2,43	60	TNIRR3210
		40 x 3,7	3,71	40	TNIRR4010
		50 x 4,6	5,86	20	TNIRR5010
		63 x 5,8	9,18	16	TNIRR6310
		75 x 6,8	12,78	12	TNIRR7510
		90 x 8,2	18,53	8	TNIRR9010
		110 x 10,0	27,40	8	TNIRR11010
		125 x 11,4	35,59	8	TNIRR12510
		160 x 14,6	68,24	4	TNIRR16010
200 x 18,2	119,28	4	TNIRR20010		





## TUBO NIRON MULTICAPA

1 / 3	 <p>TUBO NIRON SDR7,4 CON ALUMINIO EN BARRA DE 4 m. 70°C clase 2 - 8 bar 60°C clase 1 - 10 bar (PN20 S.F. 1,25)</p> <p>HASTA AGOTAR EXISTENCIAS</p>	*20 x 2,8	3,99	100	TNIRALU20
		*25 x 3,5	5,06	100	TNIRALU25
		*32 x 4,5	7,09	60	TNIRALU32
		*40 x 5,5	10,38	40	TNIRALU40
		*50 x 6,9	16,58	20	TNIRALU50
		*63 x 8,7	23,65	16	TNIRALU63
		*75 x 10,4	31,77	12	TNIRALU75
		*90 x 12,5	44,17	8	TNIRALU90
		*110 x 15,2	63,81	8	TNIRALU110
			*Dimensiones nominales sin la capa de aluminio ni recubrimiento		

## TUBO NIRON COMPUESTO

1 / 4	 <p>TUBO NIRON FG EN BARRA DE 4 m. TUBO COMPUESTO SDR 7,4 (PN20)</p> <p>70°C clase 2 - 6 bar 60°C clase 1 - 8 bar agua fría agua caliente calefacción aire acondicionado</p>	20 x 2,8	1,98	100	TNIRCFG2074
		25 x 3,5	2,84	100	TNIRCFG2574
		32 x 4,4	4,28	60	TNIRCFG3274
		40 x 5,5	7,22	40	TNIRCFG4074
		50 x 6,9	10,43	20	TNIRCFG5074
		63 x 8,7	16,51	16	TNIRCFG6374
		75 x 10,4	22,19	12	TNIRCFG7574
		90 x 12,5	32,18	8	TNIRCFG9074
		110 x 15,2	44,26	8	TNIRCFG11074
		125 x 17,1	57,17	4	TNIRCFG12574
160 x 21,9	94,79	4	TNIRCFG16074		
1 / 5 <b>NEW</b>	 <p>TUBO NIRON CLIMA EN BARRA DE 4 m. SDR 9 (PN12,5)</p> <p>aire acondicionado frío industrial energía solar instalaciones especiales NO APTO PARA AGUA POTABLE NI USO ALIMENTARIO</p>	20 x 2,8	1,98	100	TNIRCL2074
		25 x 3,5	2,78	100	TNIRCL2574
		32 x 3,6	3,30	60	TNIRCL329
		40 x 4,5	5,22	40	TNIRCL409
		50 x 5,6	7,99	20	TNIRCL509
		63 x 7,1	12,65	16	TNIRCL639
		75 x 8,4	17,87	12	TNIRCL759
		90 x 10,1	25,92	8	TNIRCL909
		110 x 10,8	31,95	8	TNIRCL11011
		125 x 11,4	42,25	4	TNIRCL12511
160 x 14,6	67,17	4	TNIRCL16011		



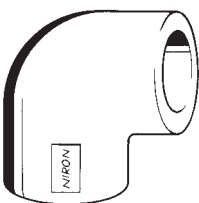
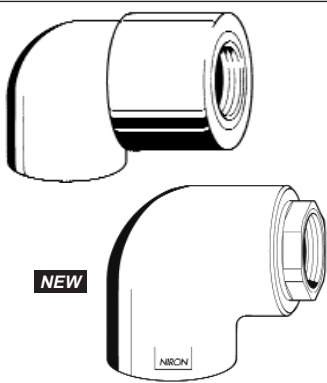
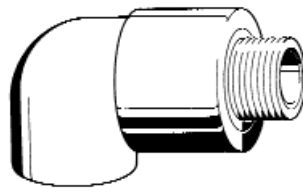

# RACOR

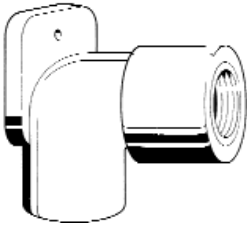
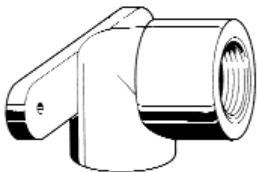
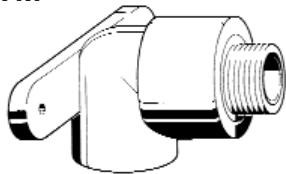
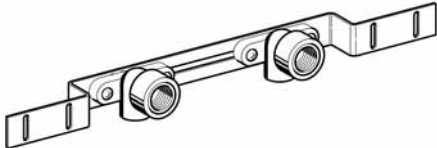
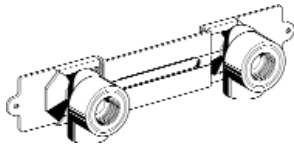
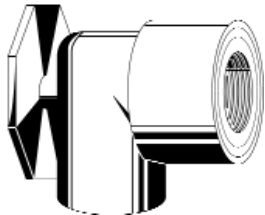
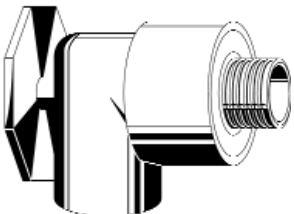
FIGURA	DESCRIPCIÓN	Ø	PRECIO	CONF.	CÓDIGO
		mm	€/uds.	uds.	
2		20	1,57	70	NCLR20
		25	2,04	50	NCLR25
85		20	1,97	50	NSOR20
		25	2,36	35	NSOR25
		32	2,96	20	NSOR32
85F		20	2,24	60	NSOFF20
		25	3,27	30	NSOFF25
85M		20	2,24	60	NSOFM20
		25	3,32	30	NSOFM25
90		16	0,46	150	NG16
		20	0,48	200	NG20
		25	0,60	130	NG25
		32	0,98	65	NG32
		40	1,93	40	NG40
		50	3,68	20	NG50
		63	5,96	10	NG63
		75	10,05	6	NG75
		90	16,59	4	NG90
		110	29,82	2	NG110
		125	46,85	1	NG125
		*160	72,93	1	NG160
		<b>NEW</b> *200	198,09	1	NG200
90F		16 x 1/2"	3,22	50	NGF1612
		20 x 1/2"	3,13	50	NGF2012
		25 x 1/2"	4,99	50	NGF2512
		25 x 3/4"	5,52	40	NGF2534
		32 x 1/2"	10,73	20	NGF3212
		32 x 3/4"	6,19	30	NGF3234
		32 x 1"	6,71	30	NGF321
		40 x 1"	12,60	10	NGF401
		<b>NEW</b> 50 x 1" 1/4	19,70	8	NGF50114
		<b>NEW</b> 50 x 1" 1/2	28,39	8	NGF50112
<b>NEW</b> 63 x 1" 1/2	35,87	6	NGF63112		
<b>NEW</b> 63 x 2"	39,88	6	NGF632		
90M		16 x 1/2"	4,90	50	NGM1612
		20 x 1/2"	4,55	50	NGM2012
		25 x 1/2"	5,40	50	NGM2512
		25 x 3/4"	5,52	40	NGM2534
		32 x 1/2"	6,73	30	NGM3212
		32 x 3/4"	6,80	30	NGM3234
		32 x 1"	13,70	20	NGM321

# RACOR

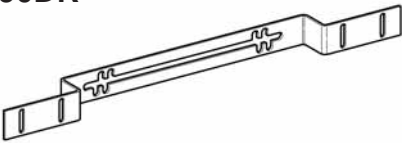
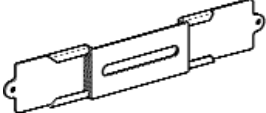
FIGURA	DESCRIPCIÓN	Ø	PRECIO	CONF.	CÓDIGO
		mm	€/uds.	uds.	
<b>90TF</b> 	<b>CODO 90° ROSCA HEMBRA Y PLACA</b>	16 x 1/2" 20 x 1/2"	<b>4,26</b> <b>4,26</b>	40 40	NTER1612 NTER2012
<b>90GTF</b> 	<b>CODO 90° ROSCA HEMBRA CON SOPORTE</b>	20 x 3/8" 20 x 1/2"	<b>4,05</b> <b>4,05</b>	40 40	NGTF2038 NGTF2012
<b>90GTM</b> 	<b>CODO 90° ROSCA MACHO CON SOPORTE</b>	20 x 3/8" 20 x 1/2"	<b>4,84</b> <b>4,84</b>	40 40	NGTM2038 NGTM2012
<b>90GR</b> 	<b>SOPORTE CON 2 CODOS Para instalaciones registrables</b>	20 x 1/2"	<b>12,57</b>	12	NGVRF2012
<b>90GV</b> 	<b>GRUPO COMPLETO Para baño o ducha</b>	20 x 1/2" 25 x 1/2"	<b>10,43</b> <b>11,33</b>	9 6	NGVF2012 NGVF2512
<b>90GVF</b> 	<b>CODO ROSCADO HEMBRA PARA GRUPO DE BAÑO</b>	20 x 1/2" 25 x 1/2"	<b>4,55</b> <b>4,92</b>	50 40	NGOF2012 NGOF2512
<b>90GVM</b> 	<b>CODO ROSCADO MACHO PARA GRUPO DE BAÑO</b>	20 x 1/2"	<b>5,13</b>	40	NGOM2012

# RACOR

FIGURA	DESCRIPCIÓN	Ø	PRECIO	CONF.	CÓDIGO
		mm	€/uds.	uds.	
<b>90DR</b> 	<b>SOPORTE PARA INSTALACIONES REGISTRABLES</b>	-	<b>4,02</b>	10	MDIMA
<b>90D</b> 	<b>NIVEL DE ACERO</b>	-	<b>2,36</b>	10	NDIMA
<b>92</b> 	<b>CODO 90°</b> <b>MACHO / HEMBRA</b>	20 25 <b>NEW</b> 32 <b>NEW</b> 40	<b>0,72</b> <b>0,91</b> <b>1,73</b> <b>2,60</b>	100 75 70 50	NGMF20 NGMF25 NGMF32 NGMF40
<b>92F</b> 	<b>CODO 90°</b> <b>MACHO / HEMBRA</b> <b>ROSCADO</b>	20 x 1/2"	<b>4,05</b>	70	NGMFF2012
<b>120</b> 	<b>CODO 45°</b>  <small>*Racor MM SDR11 para soldadura al tope o con manguito eléctrico</small>	16 20 25 32 40 50 63 75 90 110 125 *160 <b>NEW</b> *200	<b>0,53</b> <b>0,55</b> <b>0,70</b> <b>1,05</b> <b>2,34</b> <b>4,38</b> <b>5,90</b> <b>9,56</b> <b>17,91</b> <b>29,82</b> <b>41,52</b> <b>68,16</b> <b>178,92</b>	150 200 150 40 24 26 15 6 4 2 2 1 1	NC4516 NC4520 NC4525 NC4532 NC4540 NC4550 NC4563 NC4575 NC4590 NC45110 NC45125 NC45160 NC45200
<b>121</b> 	<b>CODO 45°</b> <b>MACHO / HEMBRA</b>	20 25	<b>0,76</b> <b>0,92</b>	100 70	NCMF4520 NCMF4525



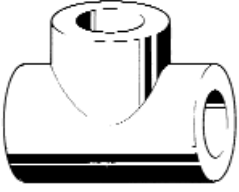
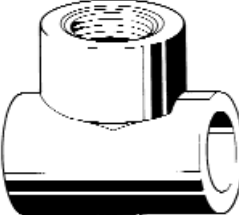
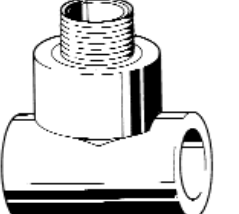
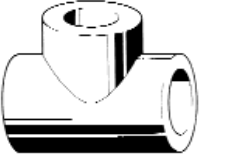

# RACOR

FIGURA	DESCRIPCIÓN	Ø	PRECIO	CONF.	CÓDIGO
		mm	€/uds.	uds.	
<b>130</b> 	<b>TE</b>  *Racor MM SDR 11 para soldadura al tope o con manguito eléctrico  <b>NEW</b>	16	<b>0,52</b>	100	NT16
		20	<b>0,55</b>	150	NT20
		25	<b>0,74</b>	90	NT25
		32	<b>1,12</b>	40	NT32
		40	<b>2,44</b>	30	NT40
		50	<b>4,60</b>	16	NT50
		63	<b>7,43</b>	8	NT63
		75	<b>11,61</b>	5	NT75
		90	<b>19,82</b>	4	NT90
		110	<b>37,65</b>	2	NT110
		125	<b>47,56</b>	1	NT125
		*160	<b>101,14</b>	1	NT160
*200	<b>207,68</b>	1	NT200		
<b>130F</b> 	<b>TE ROSCA HEMBRA</b>	16 x 1/2" x 16	<b>4,09</b>	50	NTF1612
		20 x 1/2" x 20	<b>4,07</b>	50	NTF2012
		25 x 1/2" x 25	<b>4,33</b>	40	NTF2512
		25 x 3/4" x 25	<b>5,52</b>	35	NTF2534
		32 x 1/2" x 32	<b>5,69</b>	25	NTF3212
		32 x 3/4" x 32	<b>7,57</b>	24	NTF3234
		32 x 1" x 32	<b>12,57</b>	16	NTF321
<b>130M</b> 	<b>TE ROSCA MACHO</b>	16 x 1/2" x 16	<b>5,13</b>	50	NTM1612
		20 x 1/2" x 20	<b>5,03</b>	50	NTM2012
		25 x 1/2" x 25	<b>6,01</b>	40	NTM2512
		25 x 3/4" x 25	<b>6,83</b>	30	NTM2534
		32 x 1/2" x 32	<b>8,60</b>	25	NTM3212
		32 x 3/4" x 32	<b>9,02</b>	24	NTM3234
		32 x 1" x 32	<b>13,21</b>	14	NTM321
<b>130R</b> 	<b>TE REDUCIDA</b>	16 x 20 x 16	<b>0,67</b>	150	NTR162016
		20 x 16 x 16	<b>0,67</b>	150	NTR201616
		20 x 16 x 20	<b>0,67</b>	150	NTR201620
		20 x 20 x 16	<b>0,67</b>	150	NTR202016
		25 x 16 x 25	<b>0,90</b>	90	NTR251625
		25 x 20 x 25	<b>0,90</b>	90	NTR252025
		25 x 20 x 20	<b>0,90</b>	90	NTR252020
		25 x 25 x 20	<b>0,90</b>	90	NTR252520
		32 x 20 x 25	<b>1,35</b>	40	NTR322025
		32 x 20 x 32	<b>1,35</b>	40	NTR322032
		32 x 25 x 32	<b>1,35</b>	40	NTR322532
		32 x 32 x 25	<b>1,35</b>	40	NTR323225
		40 x 20 x 40	<b>2,87</b>	14	NTR402040
		40 x 25 x 40	<b>2,87</b>	14	NTR402540
		40 x 32 x 40	<b>2,87</b>	14	NTR403240
		50 x 20 x 50	<b>4,84</b>	8	NTR502050
		50 x 25 x 50	<b>4,84</b>	8	NTR502550
		50 x 32 x 50	<b>4,84</b>	8	NTR503250
		50 x 40 x 50	<b>4,84</b>	8	NTR504050
		63 x 25 x 63	<b>6,68</b>	6	NTR632563
		63 x 32 x 63	<b>6,68</b>	6	NTR633263
		63 x 40 x 63	<b>6,68</b>	6	NTR634063
		63 x 50 x 63	<b>6,68</b>	6	NTR635063
		75 x 32 x 75	<b>14,85</b>	8	NTR753275
		75 x 40 x 75	<b>14,85</b>	5	NTR754075
		75 x 50 x 75	<b>14,85</b>	5	NTR755075
		75 x 63 x 75	<b>14,85</b>	5	NTR756375
		90 x 63 x 90	<b>23,73</b>	4	NTR906390
		90 x 75 x 90	<b>23,73</b>	4	NTR907590
		110 x 63 x 110	<b>38,33</b>	2	NTR11063110
110 x 75 x 110	<b>38,33</b>	2	NTR11075110		
110 x 90 x 110	<b>38,33</b>	2	NTR11090110		
125 x 75 x 125	<b>50,06</b>	1	NTR12575125		
125 x 90 x 125	<b>50,06</b>	1	NTR12590125		
125 x 110 x 125	<b>50,06</b>	1	NTR125110125		

# RACOR



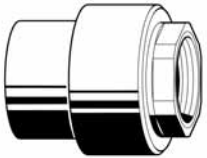

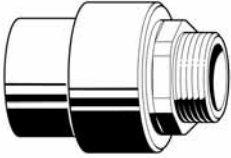
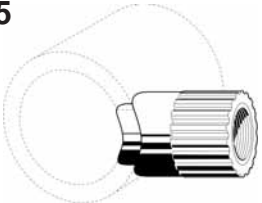

FIGURA	DESCRIPCIÓN	Ø	PRECIO	CONF.	CÓDIGO
		mm	€/uds.	uds.	
180R	CRUZ REDUCIDA	40-20-20-40	5,90	16	NCR402020
		40-25-25-40	5,90	16	NCR402525
221	CODO A 3 VÍAS	20	1,41	150	NCTV20
241	REDUCCIÓN	20/16	0,43	150	NR2016
		25/16	0,47	100	NR2516
		25/20	0,47	100	NR2520
		32/20	0,58	80	NR3220
		32/25	0,58	80	NR3225
		40/20	1,14	60	NR4020
		40/25	1,14	60	NR4025
		40/32	1,14	40	NR4032
		50/20	2,04	40	NR5020
		50/25	2,04	40	NR5025
		50/32	2,04	35	NR5032
		50/40	2,04	30	NR5040
		63/25	3,30	20	NR6325
		63/32	3,30	20	NR6332
		63/40	3,30	20	NR6340
		63/50	3,30	20	NR6350
		75/20	6,39	16	NR7520
		75/25	6,39	16	NR7525
		75/32	6,39	16	NR7532
		75/40	6,39	16	NR7540
		75/50	6,39	16	NR7550
		75/63	6,39	10	NR7563
		90/63	11,48	6	NR9063
		90/75	12,85	6	NR9075
110/63	17,94	9	NR11063		
110/75	17,94	9	NR11075		
110/90	19,56	4	NR11090		
125/110	25,23	6	NR125110		
160/125	28,71	1	NR160125		
241M	REDUCCIÓN PN 10 MACHO / MACHO PARA ACCESORIOS ELECTROSOLDABLES	75/40	9,35	16	NRMM7540
		75/50	9,35	16	NRMM7550
		75/63	9,35	12	NRMM7563
		90/50	16,08	12	NRMM9050
		90/63	16,08	12	NRMM9063
		90/75	16,07	9	NRMM9075
		110/63	21,04	6	NRMM11063
		110/75	21,04	6	NRMM11075
		110/90	21,04	6	NRMM11090
		125/75	28,44	3	NRMM12575
		125/90	28,44	4	NRMM12590
		125/110	28,44	4	NRMM125110
		<b>NEW</b> 200/160	49,21	1	NRMM200160

# RACOR

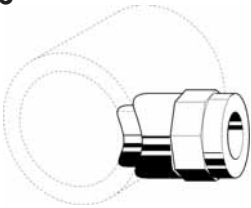

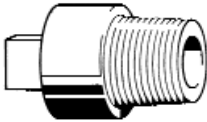
FIGURA	DESCRIPCIÓN	Ø	PRECIO	CONF.	CÓDIGO
		mm	€/uds.	uds.	
<b>270</b> 	<b>MANGUITO</b>	16	<b>0,39</b>	150	NMAN16
		20	<b>0,40</b>	300	NMAN20
		25	<b>0,48</b>	150	NMAN25
		32	<b>0,74</b>	50	NMAN32
		40	<b>1,38</b>	50	NMAN40
		50	<b>2,36</b>	20	NMAN50
		63	<b>3,65</b>	10	NMAN63
		75	<b>6,12</b>	5	NMAN75
		90	<b>10,31</b>	4	NMAN90
		110	<b>15,82</b>	4	NMAN110
125	<b>23,22</b>	4	NMAN125		
<b>270RF</b> 	<b>ENLACE ROSCA HEMBRA</b>	16 x 1/2"	<b>3,81</b>	70	NRFF1612
		20 x 1/2"	<b>3,68</b>	70	NRFF2012
		20 x 3/4"	<b>4,32</b>	50	NRFF2034
		25 x 1/2"	<b>3,88</b>	50	NRFF2512
		25 x 3/4"	<b>4,37</b>	50	NRFF2534
		32 x 3/4"	<b>7,50</b>	30	NRFF3234
		32 x 1"	<b>9,18</b>	30	NRFF321
		<b>NEW</b> 40 x 1"	<b>12,92</b>	20	NRFF401
<b>NEW</b> 40 x 1 1/4"	<b>16,53</b>	20	NRFF40114		
	<b>ENLACE ROSCA HEMBRA HEXAGONAL</b>	<b>NEW</b> 50 x 1 1/4"	<b>18,70</b>	10	NRFF50114
		50 x 1 1/2"	<b>22,49</b>	10	NRFF50112
		<b>NEW</b> 63 x 1 1/2"	<b>24,27</b>	6	NRFF63112
		63 x 2"	<b>32,64</b>	6	NRFF632
		<b>NEW</b> 75 x 2"	<b>33,01</b>	4	NRFF752
		75 x 2 1/2"	<b>44,54</b>	4	NRFF75212
		90 x 3"	<b>87,78</b>	2	NRFF903
		110 x 4"	<b>93,88</b>	2	NRFF1104
		125 x 4"	<b>108,25</b>	1	NRFF1254
		<b>270RM</b> 	<b>ENLACE ROSCA MACHO</b>	16 x 1/2"	<b>3,99</b>
20 x 1/2"	<b>3,99</b>			70	NRFM2012
20 x 3/4"	<b>4,74</b>			50	NRFM2034
25 x 1/2"	<b>4,46</b>			50	NRFM2512
25 x 3/4"	<b>4,88</b>			50	NRFM2534
32 x 3/4"	<b>8,50</b>			25	NRFM3234
32 x 1"	<b>10,19</b>			26	NRFM321
<b>NEW</b> 40 x 1"	<b>15,50</b>			15	NRFM401
	<b>ENLACE ROSCA MACHO HEXAGONAL</b>	<b>NEW</b> 40 x 1 1/4"	<b>18,98</b>	15	NRFM40114
		<b>NEW</b> 50 x 1 1/4"	<b>18,80</b>	10	NRFM50114
		50 x 1 1/2"	<b>24,52</b>	10	NRFM50112
		<b>NEW</b> 63 x 1 1/2"	<b>26,04</b>	6	NRFM63112
		63 x 2"	<b>34,98</b>	6	NRFM632
		<b>NEW</b> 75 x 2"	<b>38,76</b>	4	NRFM75212
		75 x 2 1/2"	<b>51,66</b>	4	NRFM75212
		90 x 3"	<b>96,70</b>	2	NRFM903
		110 x 4"	<b>128,09</b>	1	NRFM1104
		125 x 4"	<b>148,80</b>	1	NRFM1254
<b>275</b> 	<b>INJERTO ROSCA HEMBRA</b>	63/25 x 1/2"	<b>5,66</b>	70	NGSF6312
		63/25 x 3/4"	<b>6,72</b>	50	NGSF6334
		75/25 x 1/2"	<b>5,66</b>	70	NGSF7512
		75/25 x 3/4"	<b>6,72</b>	50	NGSF7534
		90/25 x 1/2"	<b>5,66</b>	70	NGSF9012
		90/25 x 3/4"	<b>6,72</b>	50	NGSF9034
		110/25 x 1/2"	<b>5,66</b>	70	NGSF11012
		110/25 x 3/4"	<b>6,72</b>	50	NGSF11034
		63/32 x 1"	<b>9,33</b>	30	NGSF631
		75/32 x 1"	<b>9,33</b>	30	NGSF751
		90/32 x 1"	<b>9,33</b>	30	NGSF901
		110/32 x 1"	<b>9,33</b>	30	NGSF1101

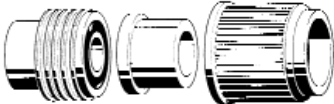
A PARTIR DE 06/2008

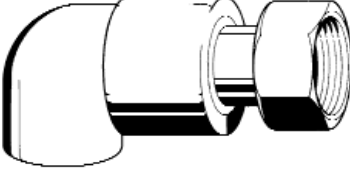
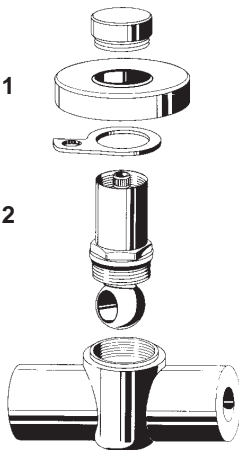
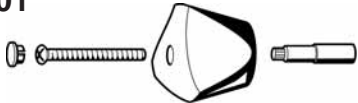
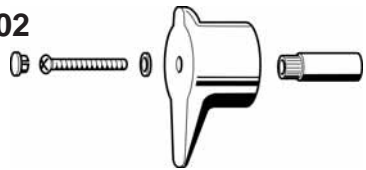

# RACOR

FIGURA	DESCRIPCIÓN	Ø	PRECIO	CONF.	CÓDIGO
		mm	€/uds.	uds.	
<b>276</b> 	<b>INJERTO</b>	50/25 x 20	<b>1,75</b>	70	NGS5020
		50/25 x 25	<b>1,75</b>	70	NGS5025
		63/25 x 20	<b>1,79</b>	70	NGS6320
		63/25 x 25	<b>1,79</b>	70	NGS6325
		75/25 x 20	<b>1,84</b>	70	NGS7520
		75/25 x 25	<b>1,84</b>	70	NGS7525
		90/25 x 20	<b>1,88</b>	70	NGS9020
		90/25 x 25	<b>1,88</b>	70	NGS9025
		110/25 x 20	<b>1,93</b>	70	NGS11020
		110/25 x 25	<b>1,93</b>	70	NGS11025
		<div style="background-color: black; color: white; padding: 5px; transform: rotate(-15deg); display: inline-block;"> <b>A PARTIR DE 06/2008</b> </div>		<div style="display: flex; align-items: center;"> <div style="background-color: black; color: white; padding: 2px 5px; font-size: 0.8em; margin-right: 5px;"><b>NEW</b></div> <div>63/32 x 32</div> </div>	<b>2,76</b>
		<div style="display: flex; align-items: center;"> <div style="background-color: black; color: white; padding: 2px 5px; font-size: 0.8em; margin-right: 5px;"><b>NEW</b></div> <div>75/32 x 32</div> </div>	<b>2,76</b>	30	NGS7532
		<div style="display: flex; align-items: center;"> <div style="background-color: black; color: white; padding: 2px 5px; font-size: 0.8em; margin-right: 5px;"><b>NEW</b></div> <div>90/32 x 32</div> </div>	<b>2,76</b>	30	NGS9032
		<div style="display: flex; align-items: center;"> <div style="background-color: black; color: white; padding: 2px 5px; font-size: 0.8em; margin-right: 5px;"><b>NEW</b></div> <div>110/32 x 32</div> </div>	<b>2,76</b>	30	NGS11032
<b>290L</b> 	<b>TAPÓN PARA NIVEL</b>	1/2" - 3/4"	<b>0,74</b>	60	NTUN
<b>290</b> 	<b>TAPÓN DE PRUEBA</b>	1/2" gas	<b>1,02</b>	100	NTC12
		3/4" gas	<b>1,25</b>	100	NTC34
<b>301</b> 	<b>TAPÓN</b>	16	<b>0,54</b>	250	NCC16
		20	<b>0,54</b>	200	NCC20
		25	<b>0,67</b>	130	NCC25
		32	<b>0,90</b>	75	NCC32
		40	<b>1,77</b>	50	NCC40
		50	<b>2,83</b>	25	NCC50
		63	<b>4,82</b>	10	NCC63
		75	<b>6,64</b>	7	NCC75
		90	<b>13,97</b>	6	NCC90
		110	<b>18,80</b>	4	NCC110
		125	<b>24,36</b>	5	NCC125
*Racor MM SDR11 para soldadura al tope o con manguito eléctrico		*160	<b>39,03</b>	1	NCC160
		*200	<b>55,11</b>	1	NCC200
<b>330</b> 	<b>UNIÓN 3 PIEZAS</b>	20	<b>5,05</b>	30	NBRF20
		25	<b>6,50</b>	26	NBRF25
		32	<b>7,36</b>	16	NBRF32
		40	<b>7,58</b>	12	NBRF40
<b>400</b> 	<b>RACOR LOCO</b>	20 x 3/4"	<b>7,23</b>	10	NBD2034
		25 x 3/4"	<b>7,49</b>	10	NBD2534
		25 x 1"	<b>8,73</b>	10	NBD251
		32 x 1"	<b>16,05</b>	5	NBD321
		32 x 1"1/4	<b>18,84</b>	5	NBD32114
		40 x 1"1/2	<b>27,53</b>	4	NBD40112
		50 x 2"	<b>65,42</b>	3	NBD502
		63 x 2"1/2	<b>86,53</b>	2	NBD63212



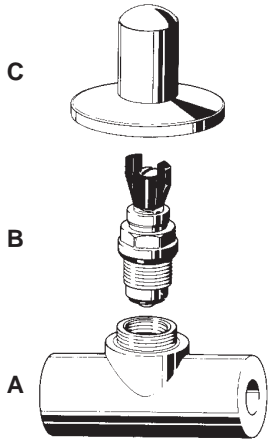
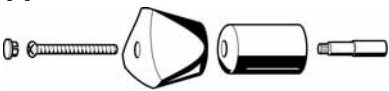
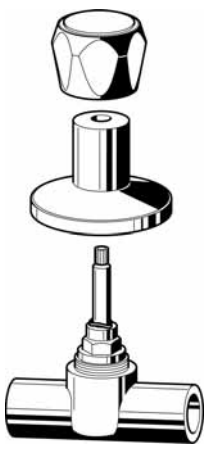

# RACOR

FIGURA	DESCRIPCIÓN	Ø	PRECIO	CONF.	CÓDIGO	
		mm	€/uds.	uds.		
<b>410</b> 	<b>CODO 90° RACOR LOCO</b>	20 x 3/4"	<b>6,75</b>	10	NBC2034	
		25 x 1"	<b>9,25</b>	10	NBC251	
		32 x 1 1/4"	<b>18,51</b>	5	NBC32114	
<b>500</b> 	<b>LLAVE DE PASO ESFERA COMPLETA</b>	20	<b>22,55</b>	10	NRS20	
		25	<b>24,46</b>	10	NRS25	
		32	<b>26,87</b>	10	NRS32	
	<b>RECAMBIOS</b>					
	<b>1 Embellecedor</b>		20-25-32	<b>7,43</b>	1	NRSRC
	<b>2 Montura esfera</b>		20-25 32	<b>13,55</b> <b>15,45</b>	1 1	NRSRS2025 NRSRS32
<b>Alargador L=22 mm.</b>		20-25-32	<b>6,15</b>	10	NPROSF	
<b>501</b> 	<b>MANDO para art. 500</b>	para NRS 20-25-32	<b>8,49</b>	10	NMAS	
<b>502</b> 	<b>LEVA para art. 500</b>	para NRS 20-25-32	<b>12,01</b>	1	NLRS	
<b>500/B</b> 	<b>LLAVE DE PASO ESFERA en PPR</b>	20	<b>12,51</b>	30	NRSP20	
		25	<b>16,47</b>	25	NRSP25	
		32	<b>22,62</b>	15	NRSP32	
		40	<b>47,80</b>	8	NRSP40	
		50	<b>68,88</b>	6	NRSP50	
		63	<b>102,56</b>	3	NRSP63	
		75	<b>160,45</b>	1	NRSP75	
		90	<b>236,91</b>	1	NRSP90	
		110	<b>407,94</b>	1	NRSP110	
		<b>NEW</b> 125	<b>590,00</b>	1	NRSP125	

# RACOR

FIGURA	DESCRIPCIÓN	Ø	PRECIO	CONF.	CÓDIGO
		mm	€/uds.	uds.	
<b>510</b> 	<b>LLAVE DE PASO COMPLETA</b>	20 25	<b>17,76</b> <b>19,04</b>	10 10	NRA20 NRA25
	<b>RECAMBIOS</b>				
	<b>A Sólo cuerpo</b>	20 25	<b>10,51</b> <b>11,10</b>	20 20	NCRA20 NCRA25
	<b>B Montura de recambio</b>	20 25	<b>5,75</b> <b>6,02</b>	1 1	NVIT20 NVIT25
	<b>C Embellecedor</b>	20/25	<b>10,22</b>	1	NRARC
	<b>Alargador L=20 mm.</b>	20/25	<b>8,41</b>	10	NPROVI
<b>511</b> 	<b>MANDO PARA LLAVE DE PASO DE ASIENTO</b>	para NRA 20-25	<b>8,89</b>	10	NMAVI
<b>512</b> 	<b>LLAVE DE PASO DE ASIENTO ALARGADA</b>	20 25	<b>26,44</b> <b>27,78</b>	10 10	NRAPRO20 NRAPRO25
<b>515</b> 	<b>VÁLVULA DE ASIENTO OBLÍCUO</b>	20 25 32	<b>20,17</b> <b>21,30</b> <b>30,08</b>	15 10 6	NRAIN20 NRAIN25 NRAIN32

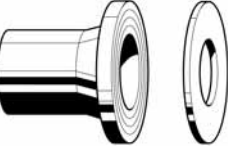
# RACOR

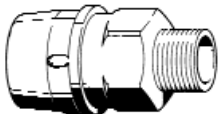
FIGURA	DESCRIPCIÓN	Ø	PRECIO	CONF.	CÓDIGO	
		mm	€/uds.	uds.		
520	<b>A CASQUILLO CON JUNTA TÓRICA</b> 	32	2,85	100	NCOSA32	
		40	3,27	50	NCOSA40	
		50	3,57	30	NCOSA50	
		63	5,83	20	NCOSA63	
		75	7,42	10	NCOSA75	
	<b>B CASQUILLO CON JUNTA PLANA</b> 	90	13,84	8	NCOSA90	
		110	20,05	10	NCOSA110	
		125	36,61	8	NCOSA125	
	<b>C CASQUILLO A SOLDAR</b> *Racor MM SDR11 para soldadura al tope o con manguito eléctrico ART. NME 	*160	28,86	1	NCOSA160	
		<b>NEW</b> *200	98,00	1	NCOSA200	
	521	<b>BRIDA DE ALUMINO Para Casquillo fig. 520</b> 	32	10,61	1	NFLA32
			40	18,52	1	NFLA40
			50	20,02	1	NFLA50
63			22,56	1	NFLA63	
75			30,41	1	NFLA75	
90			34,52	1	NFLA90	
110			38,74	1	NFLA110	
125			47,36	1	NFLA125	
160			60,02	1	NFLA160	
<b>NEW</b> 200			95,17	1	NFLA200	
600	<b>RACOR DE LATÓN ROSCA HEMBRA Sólo para agua fría</b> 	20 x 1/2"	10,42	1	BF2012	
		25 x 3/4"	14,78	1	BF2534	
		32 x 1"	20,85	1	BF321	
		40 x 1"1/4	35,10	1	BF40114	
		50 x 1"1/2	45,94	1	BF50112	
		63 x 2"	65,10	1	BF632	
		75 x 2"1/2	84,21	1	BF75212	
		90 x 3"	126,44	1	BF903	
110 x 4"	176,84	1	BF1104			
610	<b>RACOR DE LATÓN ROSCA MACHO Sólo para agua fría</b> 	20 x 1/2"	10,42	1	BM2012	
		25 x 3/4"	14,78	1	BM2534	
		32 x 1"	20,85	1	BM321	
		40 x 1"1/4	35,10	1	BM40114	
		50 x 1"1/2	45,94	1	BM50112	
		63 x 2"	65,10	1	BM632	
		75 x 2"1/2	84,21	1	BM75212	
		90 x 3"	126,44	1	BM903	
110 x 4"	176,84	1	BM1104			

# ACCESORIOS ELECTROSOLDABLES PN10 CON MÁQUINA CÓD. NSEM/E8300









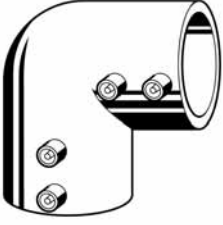

FIGURA	DESCRIPCIÓN	Ø	PRECIO	CONF.	CÓDIGO
		mm	€/uds.	uds.	
<p>Sólo para instaladores cualificados, que hayan atendido un curso de soldadura o que respeten íntegramente las instrucciones de instalación indicadas en nuestro manual técnico.                      NUPI S.P.A. / ITALSAN no asumen ninguna responsabilidad por daños provocados por errores de instalación.</p>					
<b>90E</b>  	<b>CODO 90° ELÉCTRICO</b>	40	<b>29,58</b>	20	NGE40
		50	<b>31,17</b>	12	NGE50
		63	<b>38,47</b>	8	NGE63
		75	<b>50,72</b>	4	NGE75
		90	<b>58,81</b>	2	NGE90
		110	<b>92,46</b>	1	NGE110
<b>120E</b>  	<b>CODO 45° ELÉCTRICO</b>	40	<b>24,89</b>	20	NCE40
		50	<b>27,90</b>	16	NCE50
		63	<b>35,02</b>	8	NCE63
		75	<b>44,44</b>	6	NCE75
		90	<b>58,81</b>	2	NCE90
		110	<b>108,90</b>	2	NCE110
<b>130E</b>  	<b>TE ELÉCTRICA</b>	40	<b>38,08</b>	12	NTE40
		50	<b>50,26</b>	8	NTE50
		63	<b>54,72</b>	4	NTE63
		75	<b>60,23</b>	4	NTE75
		90	<b>125,25</b>	2	NTE90
		110	<b>163,33</b>	1	NTE110
<b>270E</b>  	<b>MANGUITO ELÉCTRICO</b>	20	<b>6,64</b>	30	NME20
		25	<b>6,93</b>	30	NME25
		32	<b>7,97</b>	30	NME32
		40	<b>8,95</b>	30	NME40
		50	<b>9,73</b>	20	NME50
		63	<b>11,51</b>	18	NME63
		75	<b>20,32</b>	10	NME75
		90	<b>22,75</b>	8	NME90
		110	<b>24,29</b>	8	NME110
		125	<b>44,99</b>	2	NME125
		160	<b>62,68</b>	1	NME160
		<b>NEW</b> 200	<b>110,40</b>	1	NME200

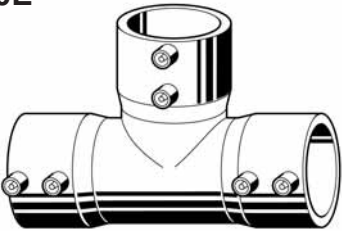
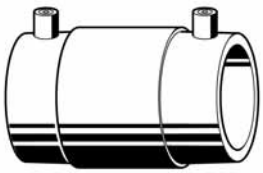
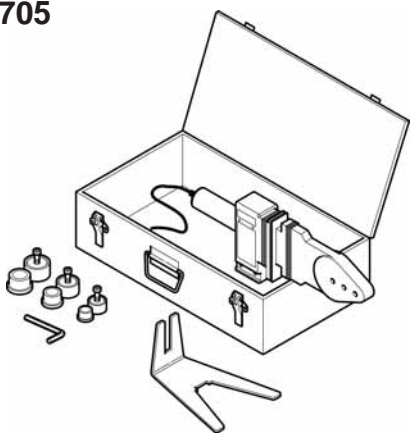
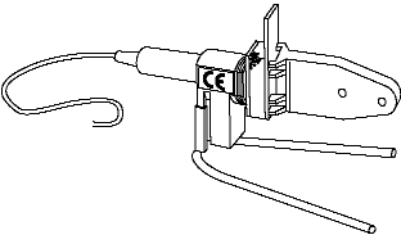
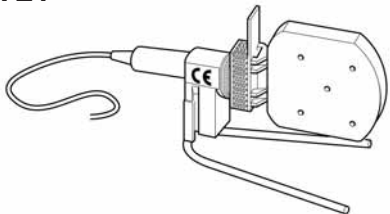
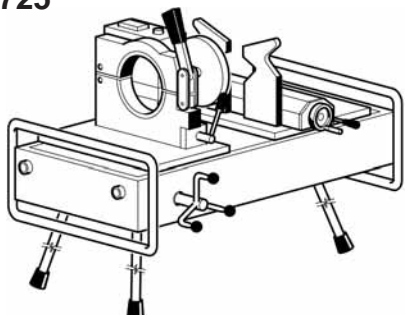
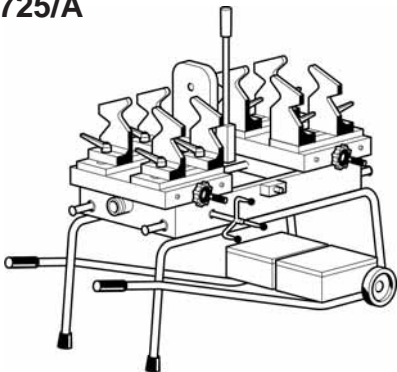
FIGURA	DESCRIPCIÓN	Ø	PRECIO	CONF.	CÓDIGO
		mm	€/ud.	ud.	
705	 <p>POLIFUSOR CON MALETÍN Y CON MATRICES Ø 20-25-32 800 W</p>	20-25-32	450,76	1	NSBEP
720	 <p>POLIFUSOR CON CABALLETE Ø máx. 63 mm. 800 W</p>	16/63	306,41	1	NPCCE
721	 <p>POLIFUSOR CON CABALLETE Ø máx. 125 mm. 1400 W</p>	16/125	622,95	1	NPCCE125
725	 <p>SOLDADOR POLIFUSOR CON MATRICES Ø máx. 90 mm. 1000 W</p>	20-90	4.558,20	1	NSTL90
725/A	 <p>SOLDADOR POLIFUSOR CON MATRICES Ø máx. 125 mm. 1400 W</p>	25-125	10.889,03	1	NSTL125

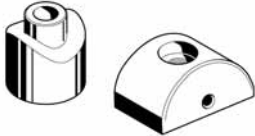
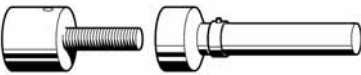
# HERRAMIENTAS Y ÚTILES SISTEMA NIRON

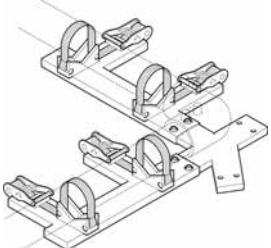
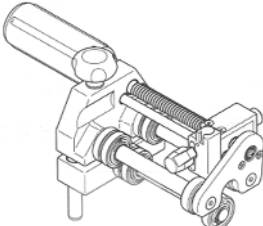
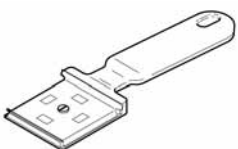
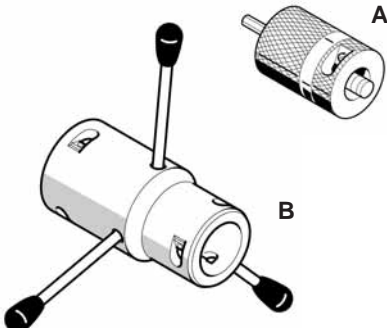
FIGURA	DESCRIPCIÓN	Ø	PRECIO	CONF.	CÓDIGO
		mm	€/ud.	ud.	
<b>730</b> 	<b>MATRICES PARA POLIFUSOR</b>	16	<b>46,59</b>	1+1	NMATRICE16
		20	<b>46,85</b>	1+1	NMATRICE20
		25	<b>49,13</b>	1+1	NMATRICE25
		32	<b>55,71</b>	1+1	NMATRICE32
		40	<b>71,41</b>	1+1	NMATRICE40
		50	<b>85,34</b>	1+1	NMATRICE50
		63	<b>98,25</b>	1+1	NMATRICE63
		75	<b>129,15</b>	1+1	NMATRICE75
		90	<b>174,73</b>	1+1	NMATRICE90
		110	<b>240,57</b>	1+1	NMATRICE110
		125	<b>286,15</b>	1+1	NMATRICE125
		<b>731</b> 	<b>MATRICES PARA INJERTO NGS y NGSF</b>	50/25	<b>100,53</b>
63/25	<b>100,53</b>			1+1	NMATGS63
75/25	<b>100,53</b>			1+1	NMATGS75
90/25	<b>100,53</b>			1+1	NMATGS90
110/25	<b>100,53</b>			1+1	NMATGS110
<b>NEW</b> 63/32	<b>146,22</b>			1+1	NMATGS6332
<b>NEW</b> 75/32	<b>146,22</b>			1+1	NMATGS7532
<b>NEW</b> 90/32	<b>146,22</b>			1+1	NMATGS9032
<b>NEW</b> 110/32	<b>146,22</b>	1+1	NMATGS11032		
<b>742</b> 	<b>MATRICES PARA REPARAR UN TUBO TALADRADO</b>	MATRIZ 7	<b>94,96</b>	1+1	NMARP7
		Agujero Ø 6 máx.	<b>94,96</b>	1+1	NMARP11
		11			
<b>743</b> 	<b>TAPÓN DE REPARACIÓN</b>	7/11	<b>0,85</b>	100	NCAR711
<b>745</b> 	<b>SOLDADOR PARA ACCESORIOS ELECTROSOLDABLES</b>	20÷125	<b>3.798,50</b>	1	NSEM
<b>746</b> 	<b>ALINEADOR PARA ACCESORIOS ELECTROSOLDABLES</b>	20÷63	<b>741,97</b>	1	NEALL63
		40÷180	<b>1.228,18</b>	1	NEALL180
<b>747</b> 	<b>RASCADOR TANGENCIAL</b>  Hoja	25÷180	A consultar	1	NRAT1
			A consultar	1	NRATLR

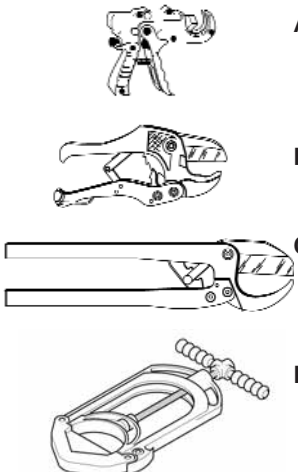
# HERRAMIENTAS Y ÚTILES SISTEMA NIRON

FIGURA	DESCRIPCIÓN	Ø	PRECIO	CONF.	CÓDIGO	
		mm	€/ud.	ud.		
748 	RASCADOR	-	41,02	1	NRAM1	
660 	UTIL PARA PELAR TUBO CON ALUMINIO	A	20	85,59	1	NFTAL20
			25	85,59	1	NFTAL25
			32	85,59	1	NFTAL32
			40	108,89	1	NFTAL40
		B	50-63	157,00	1	NFTAL5063
	75-90	245,64	1	NFTAL7590		
	A	110	273,49	1	NFTAL110	
661 	FRESA PARA INJERTO para NGS	25 32	226,14 204,00	1 1	NFGS25 NFGS32	
750 	TIJERAS PARA TUBOS	A	16÷32	70,20	1	NTTTP
		B	16÷40	39,51	1	NTTT1
		C	16÷75	245,64	1	NTTT2
		D	16÷125	1.729,59	1	NTTT3
			HOJA PARA NTTTP	-	33,43	1
620 	NIVEL	-	30,17	1	NDA	

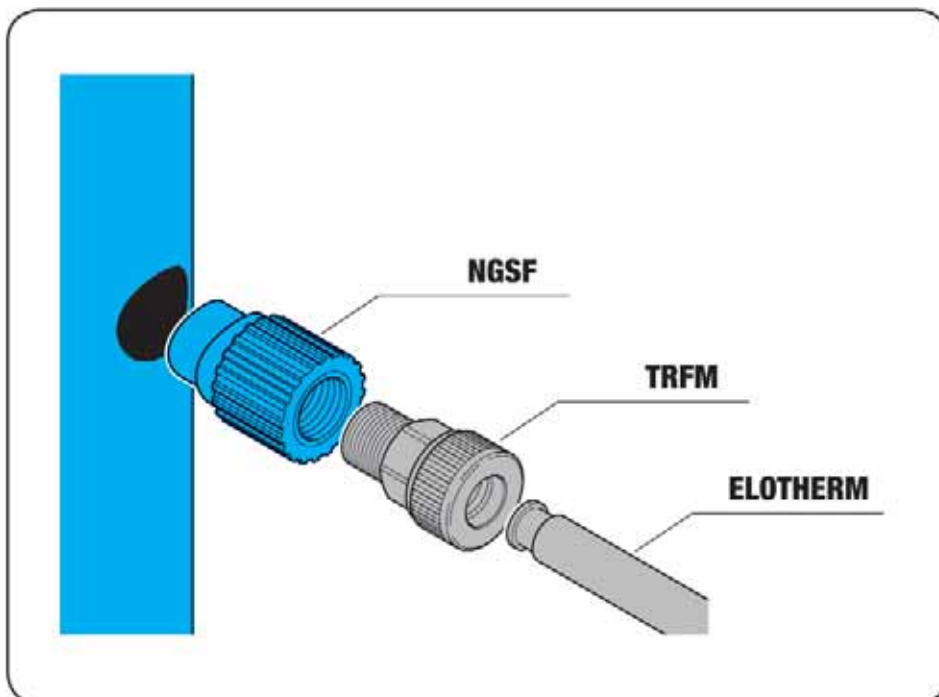
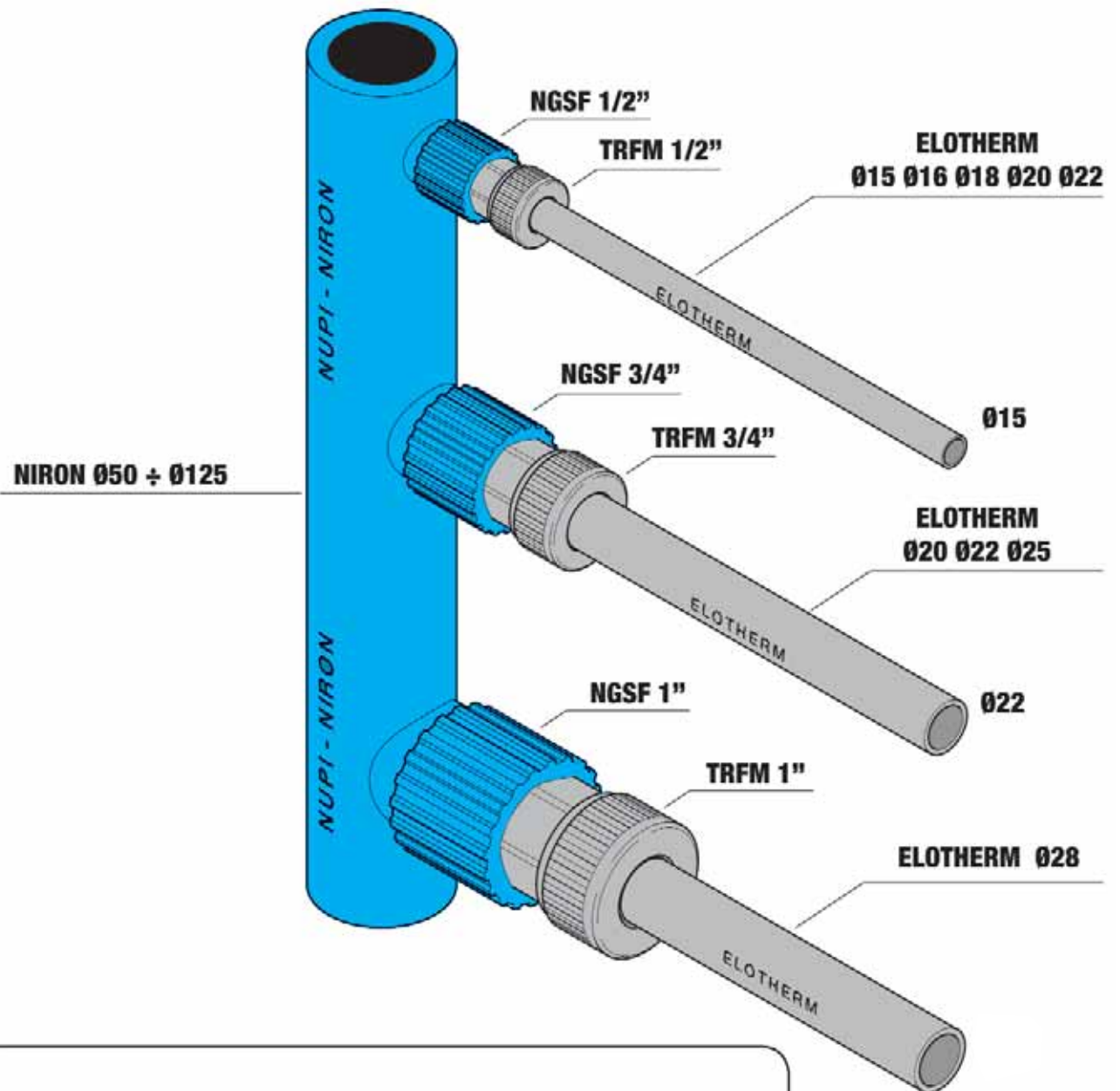

# Condiciones generales de venta

## 1. Precios

Los precios que se indican en esta tarifa son sin IVA.

Los precios de esta tarifa se entienden para el producto situado en nuestros almacenes.

## 2. Pedidos

Los pedidos se formalizarán siempre por escrito vía fax.

## 3. Devoluciones

No se admiten devoluciones de material transcurridos 15 días a la fecha de entrega del material.

En los casos excepcionales, de aceptación de devolución, éstos deberán estar acordados por escrito entre ITALSAN y el CLIENTE y deberán cumplir los requisitos de devolución a portes pagados y demérito del 20%.

# Productos Italsan

## Edificación

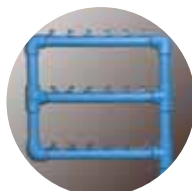

### Baterías Italsan (PPR)

Baterías de Polipropileno para contadores de agua.



### Colectores Italsan (PPR)

Colectores de Polipropileno para contadores de agua.



### Niron (PPR)

Tubería y accesorios de Polipropileno para instalaciones hidrosanitarias.



### Niron FG® Fiber Glass (PPR)

Tubería de Polipropileno reforzada con fibra, anulando las dilataciones.



### Niron Clima (PPR)

Tuberías de Polipropileno reforzada con fibra para instalaciones de climatización.



### Elotherm (PB)

Tuberías y accesorios a compresión de polibutileno para instalaciones hidrosanitarias.

## Obra Civil / Sector Industrial



### Elofit (PEAD)

Accesorios electrosoldables, de transición, polivalentes y manipulados de Polietileno para sistemas de tuberías con presión de agua y gas.



### Elopress (PP)

Accesorios a compresión de Polipropileno para sistemas de tuberías con presión de agua fría.



### SmartFlex (PEHD/Poliamida)

Tuberías y accesorios de Polietileno con poliamida para conducción de hidrocarburos y afines. Sistema de simple y doble pared.



### Saneamiento (PVC-PE)

Accesorios de PVC color teja y corrugados para saneamiento, gran diámetro.



**NUPI ha obtenido la certificación de sus sistema de calidad empresarial en conformidad con las normas internacionales ISO 9001:2000.**  
**Esta prestigiosa certificación es el fruto del esfuerzo producido por cada una de las fuentes productivas de la empresa en los procesos de producción y en los distintos controles utilizados para garantizar el respeto de los estándares requeridos.**



**NUPI S.p.A.**

Via Dell'Artigianato, 13 - 40023 Castel Guelfo di Bologna - Italy  
 Tel. (39) 0542 624911 - Fax (39) 0542 670851 - E-Mail: [infoplumbing@nupinet.com](mailto:infoplumbing@nupinet.com)  
 Sito Web: <http://www.nupinet.it>



**Delegaciones:**

Sede Barcelona  
 C/ de la Máquina, 8 B  
 Pol. Ind. El Regàs  
 08850 Gavà (Barcelona)  
 TEL. 93 630 30 40  
 Fax 93 633 60 42

Sede Madrid  
 Ronda de Valdecarrizo, 47, Nave 7A  
 28760 Tres Cantos (Madrid)  
 Tel. 91 806 07 23  
 Fax 91 803 30 49

**Sistemas de tuberías plásticas**

Atención al cliente:  
 902 20 31 41

[www.italсан.es](http://www.italсан.es)  
[atencionalcliente@italсан.es](mailto:atencionalcliente@italсан.es)

Distribuidor



**italсан** grupo